

HEAD PARTS AND PARTS NAME

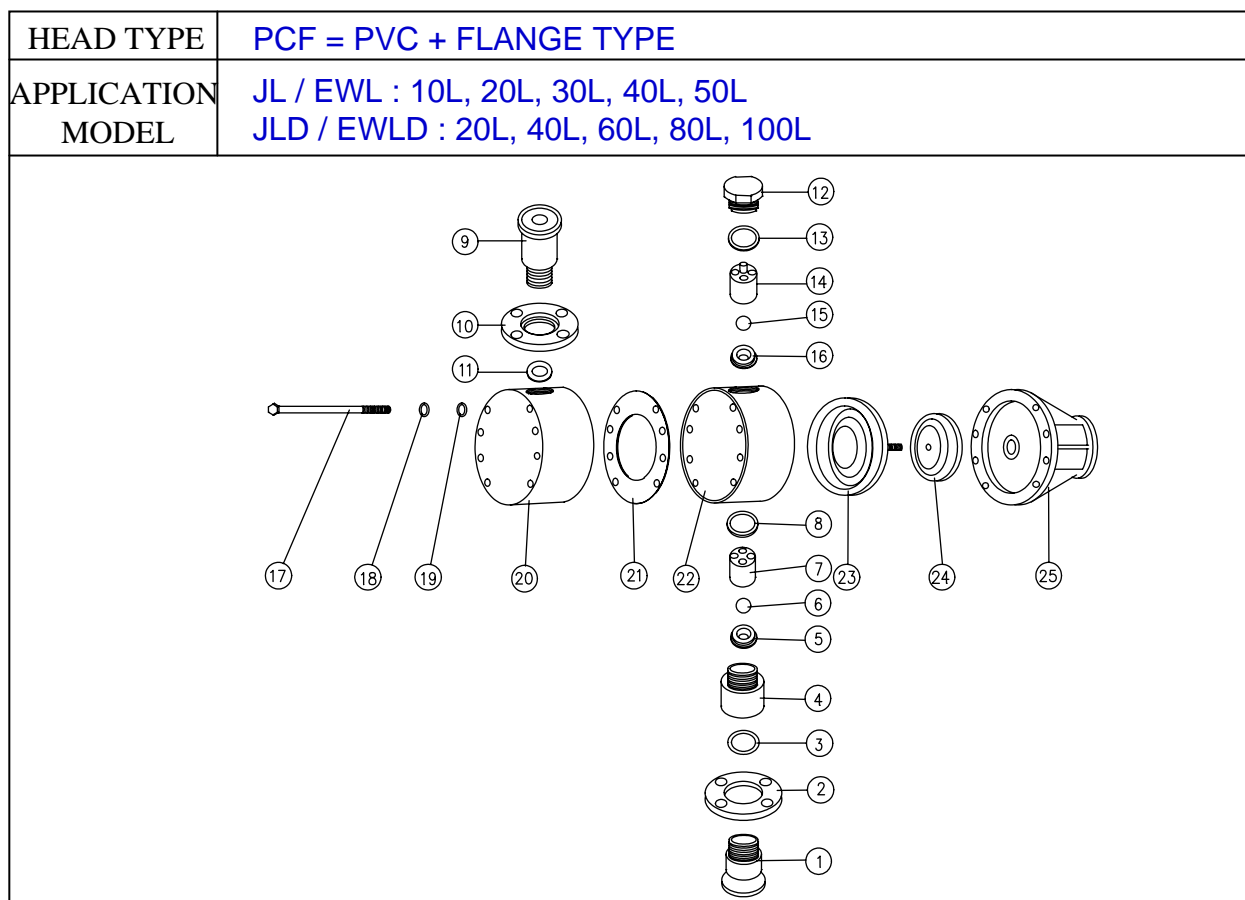

- ※ 1. The numbers are indicated the order of disassembly, that will help your assembly.
2. DO NOT DISASSEMBLE NO.24 P.FLANGE.

No.	DRAWING NO.	PART NAME	Q'TY	REMARK
1		SUC.CONNECTOR	1	
2		FLANGE	1	
3		GASKET	1	
4		SUC.CONN.NO2	1	
5		BALL SEAT	1	
6		CHECK BALL	1	
7		S.BALL GUIDE	1	
8		GASKET	1	
9		DIS.CONNECTOR	1	
10		FLANGE	1	
11		GASKET	1	
12		HEAD CAP	1	
13		GASKET	1	
14		D.BALL GUIDE	1	

No.	DRAWING NO	PART NAME	Q'TY	REMARK
15		CHECK BALL	1	
16		BALL SEAT	1	
17		HEX. BOLT	8	
18		SPRING WASHER	8	
19		PLANE WASHER	8	
20		HEAD CHAMBER	1	
21		GASKET	1	
22		PUMP HEAD	1	
23		DIAPHRAGM	1	
24		PUSH PLATE	1	
25		PUMP FLANGE	1	